

Niloé™ Room thermostat with pilot wire

Cat. No(s): 7 645 87 - 7 646 87

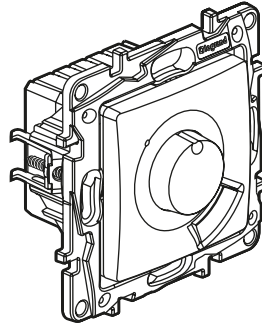

1. USE

This thermostat can control heaters type convectors / radiant heaters or direct heating floors and ceilings.
 It can also be used with heated floors or ceilings.
 The thermostat is equipped with a terminal for a pilot wire. With this wire, the thermostat can be controlled remotely using the standard driver wireless feature signals.
 It interprets the following six orders: comfort, comfort-1, 2-comfort, eco, frost-stop.

2. RANGE

Description	White	Ivory
Room thermostat Can be used with energy manager Cat. No. 0 038 21 via pilot wire input. Can be used with a timer for comfort or economy mode. To be equipped with plate.	7 645 87	7 646 87

3. DIMENSIONS (mm)

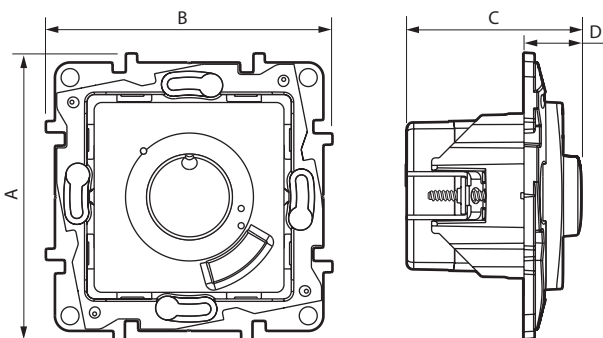

A	B	C	D
76	76	46.5	15.5

4. CONNECTION

Number of terminals: 5
 Type of terminals: with screws
 Terminal capacity: 1 x 2.5 mm² flexible or rigid
 Stripping length: 6 mm
 Screwdriver: flat 3.5 mm

4.1 Wiring: Operation with pilot wire (6 GIEAM commands)

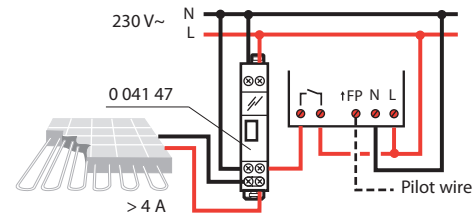
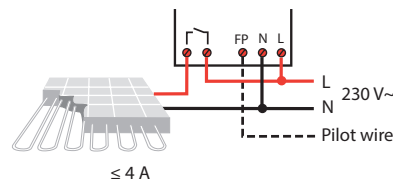

4.2 Wiring: Operation with programmable time switch (Comfort/Economy)

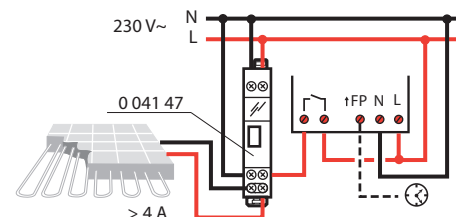
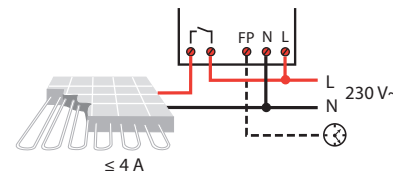

Room thermostat with pilot wire

5. OPERATION

Breaking capacity: 4 A max.

Adjustment range from 7 to 30° C using the control dial.

1 function associated with the selection dial:

- short press: selects the regulation mode (comfort, economy, frost protection)

Adjustment accuracy: $\pm 0.5^\circ$

4 A NO or NC contact relay.

Adjustment (thermostat controlled by pilot wire):

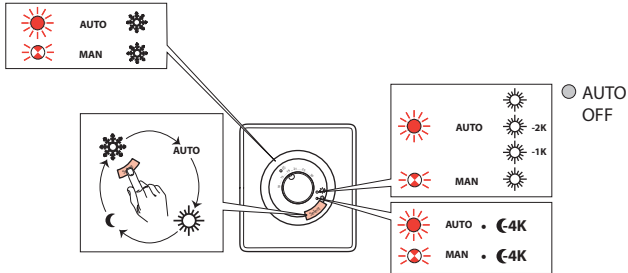

Adjustment (thermostat controlled by programmable time switch):

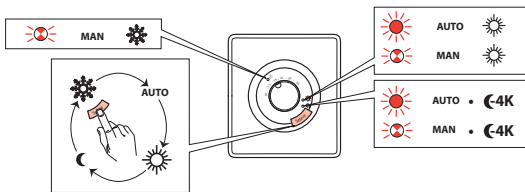

Key

- Operation in automatic mode (thermostat controlled by pilot wire or time switch)
- Operation in manual mode (thermostat controlled by user)
- Frost protection
- Comfort mode
- Economy mode (4° C lower than comfort mode)

6. TECHNICAL CHARACTERISTICS

■ 6.1 Mechanical characteristics

Protection against solid bodies and liquids: IP 30

Protection against impact: IK 04

■ 6.2 Material characteristics

Polyglass appearance

Colour : - White RAL 9003

- Ivory RAL 1013

Material: - Cover plate and rocker: ABS

- Halogen free

- UV resistant

Material of the support: - PC grey RAL 7037 + 10% glass fiber

- Halogen free

Self-extinguishing:

+ 850° C / 30 s for insulating parts holding live parts in place.

+ 650° C / 30 s for other parts made of insulating materials.

■ 6.3 Climatic characteristics

Voltage: 230 V~

Current: 8 A

Frequency: 50/60 Hz

■ 6.4 Climatic characteristics

Storage temperature: - 10° C to + 70° C

Use temperature: + 7° C to + 40° C

7. CLEANING

Surface cleaning with a cloth.

Do not use: acetone, tar remover, trichloroethylene.

Maintenance with the following products: Hexane (EN 60669-1), Methylated spirit, Soapy water, Diluted ammonia, Bleach diluted to 10%, Window-cleaning products.

Caution: A preliminary test should be carried out if other specific cleaning products are to be used.

8. STANDARDS AND APPROVALS

Compliant with installation and manufacturing standards.

See e-catalogue.